

**C60**  
**C60 YALITIMSIZ SERİ PROFİLLERİ**  
C60 ECHOTERM SERIES

**Alařım Özellikleri**  
Alloy Properties

EN AW 6060 (AlMgSi0,5 F22) EN AW 6063(AlMg0,7Si F22)

**Üretim ve Mekanik Standartları**  
Production and Mecanical Standards

EN 12020-2 - EN 755-9 - EN 755-2

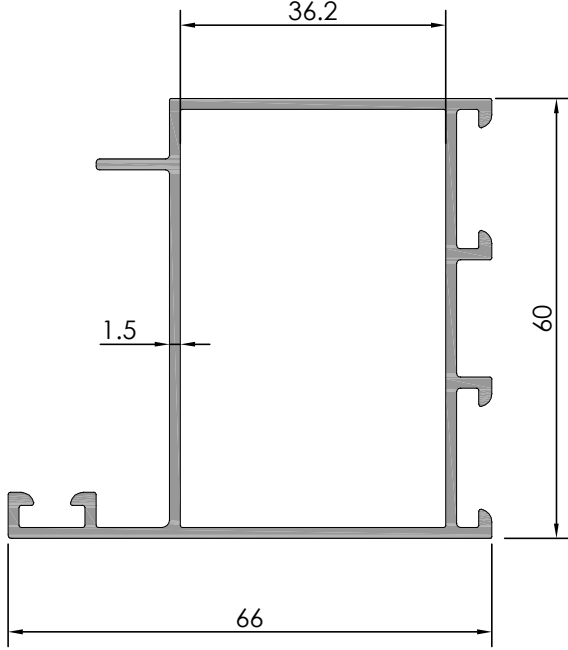

C60-2536

Ağırlık : 1.084 Kg/m

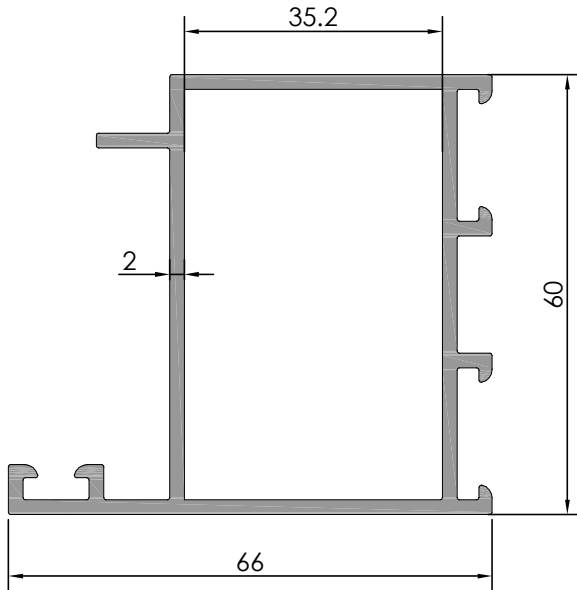

C60-1681

Ağırlık : 1.404 Kg/m

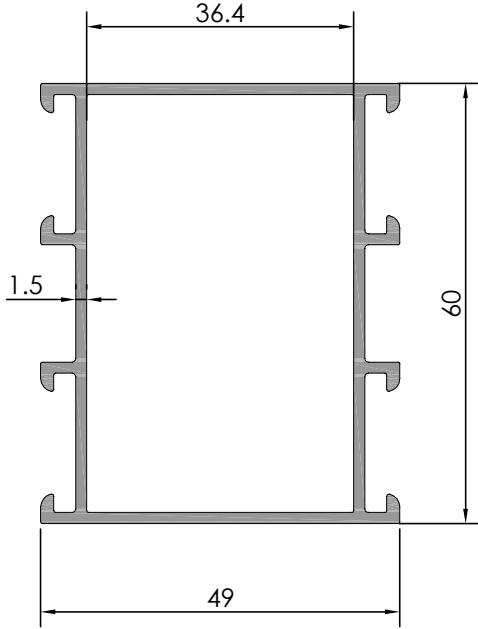

C60-2537

Ağırlık : 1.021 Kg/m

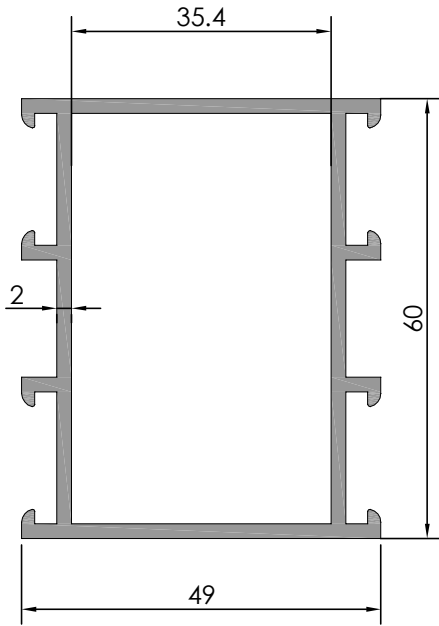

C60-1682

Ağırlık : 1.300 Kg/m

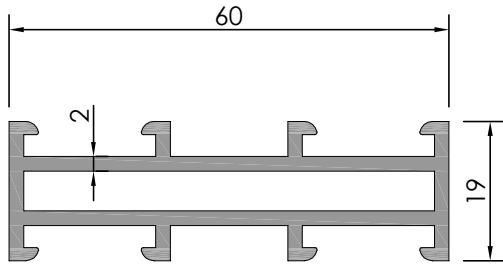
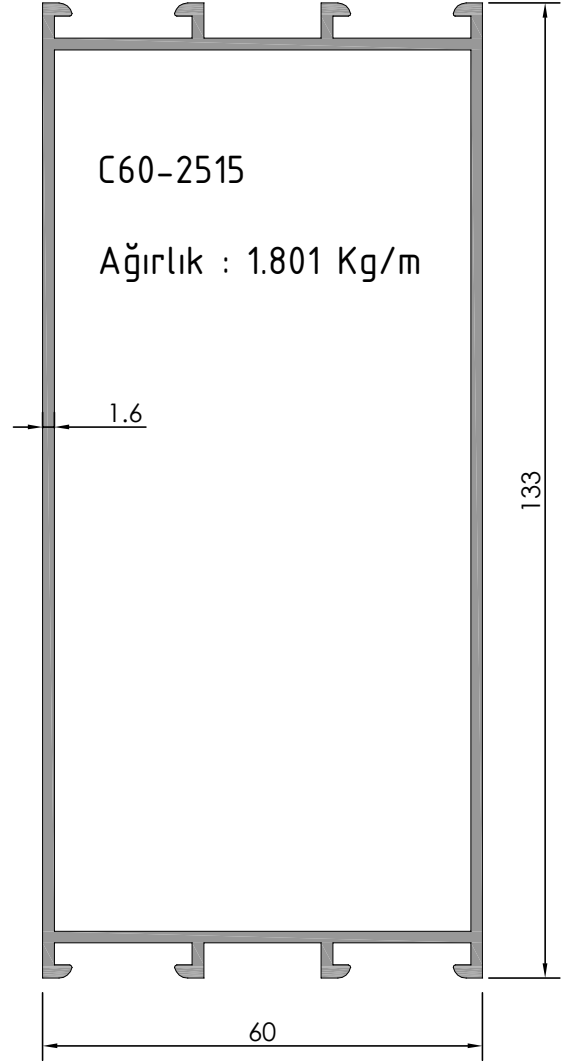
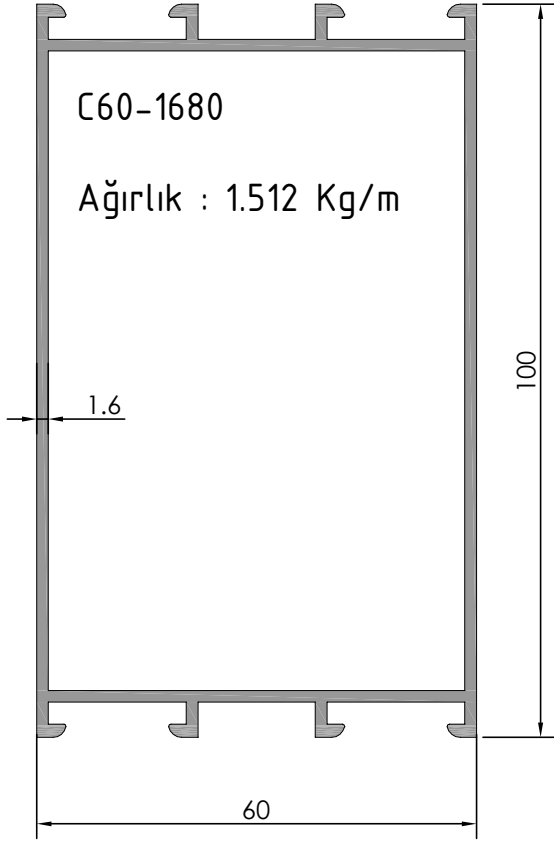

C60-1683  
Ağırlık : 0.976 Kg/m

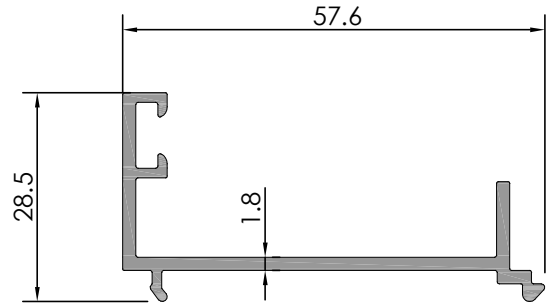

C60-1685  
Ağırlık : 0.515 Kg/m

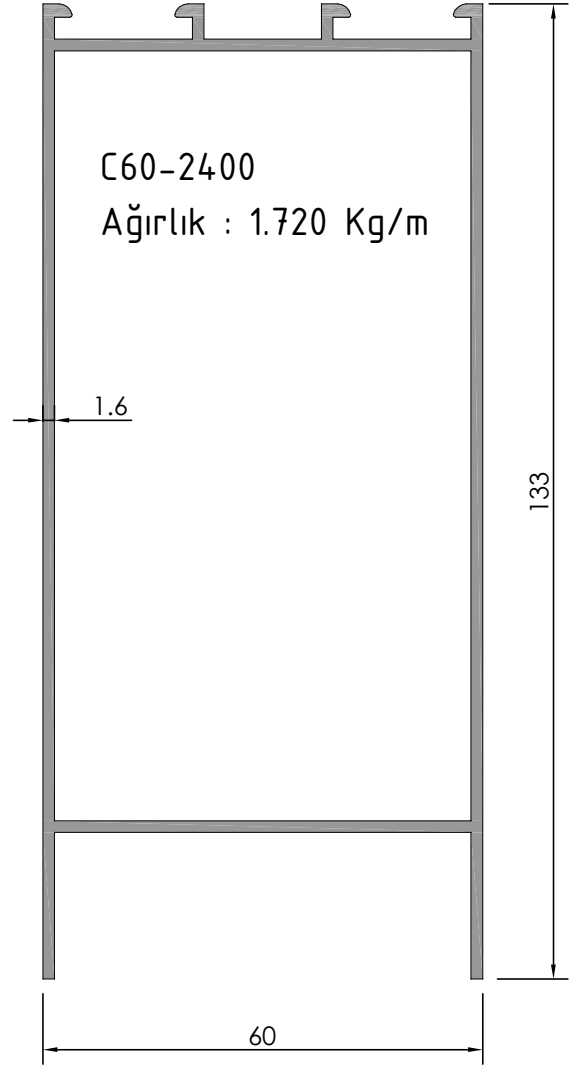
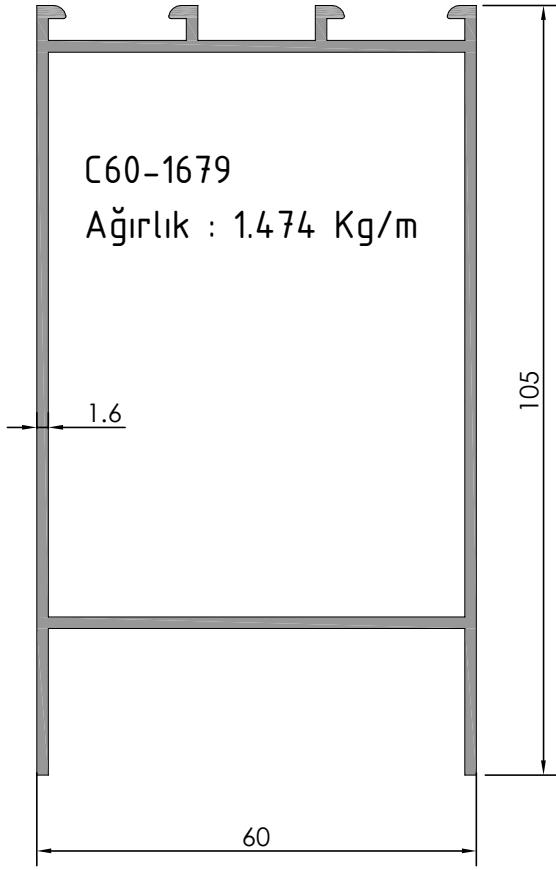

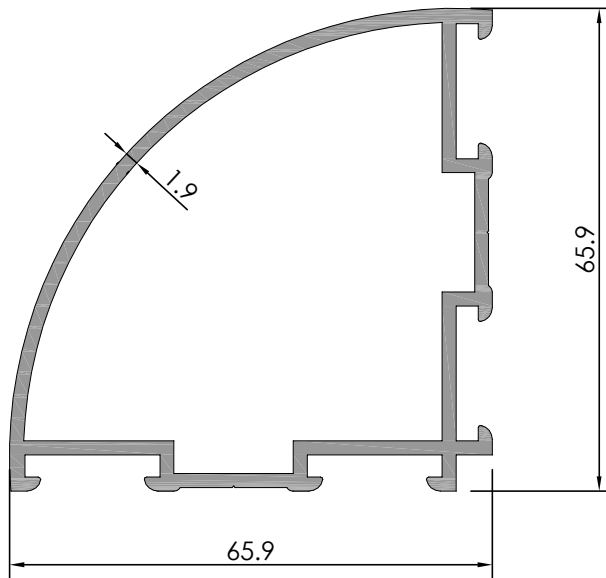
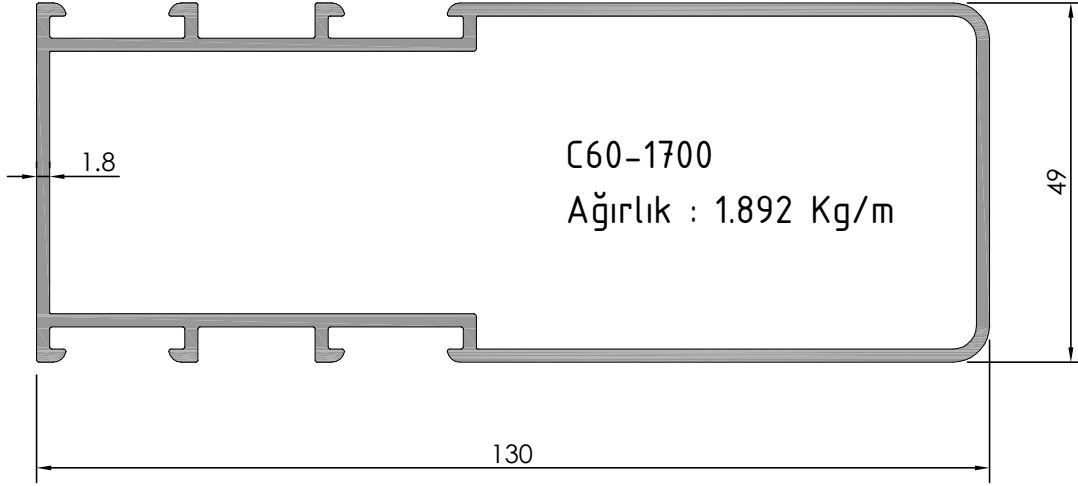

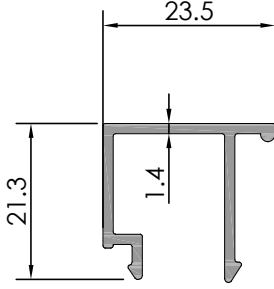

C60-1686  
Ağırlık : 0.265 Kg/m

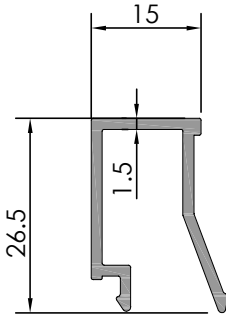

C60-1687  
Ağırlık : 0.284 Kg/m

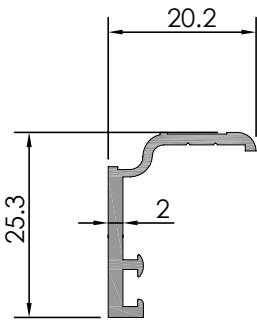

C60-1688  
Ağırlık : 0.216 Kg/m

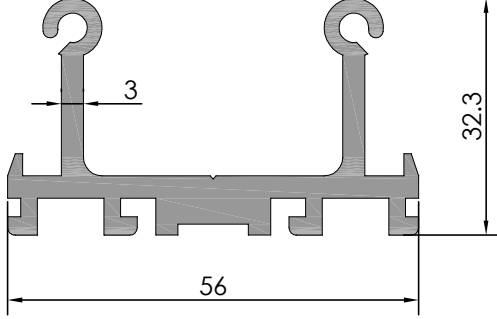

C60-1684  
Ağırlık : 1.288 Kg/m

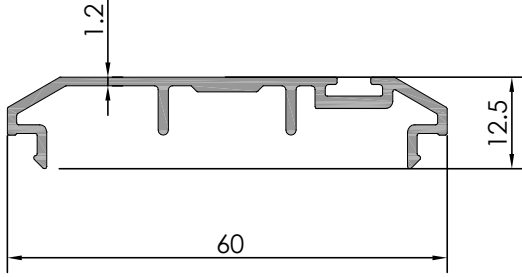

C60-11187  
Ağırlık : 0.400 Kg/m

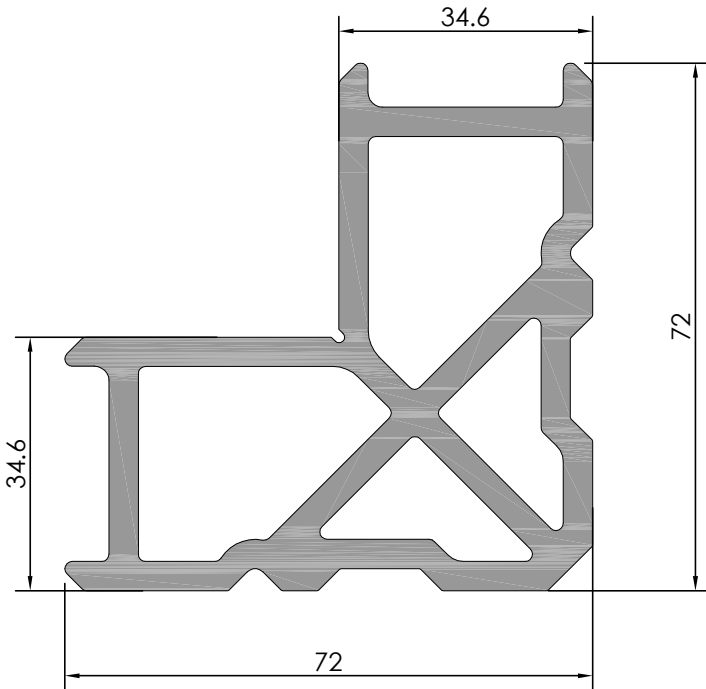

W-613  
Ağırlık : 3.933 Kg/m

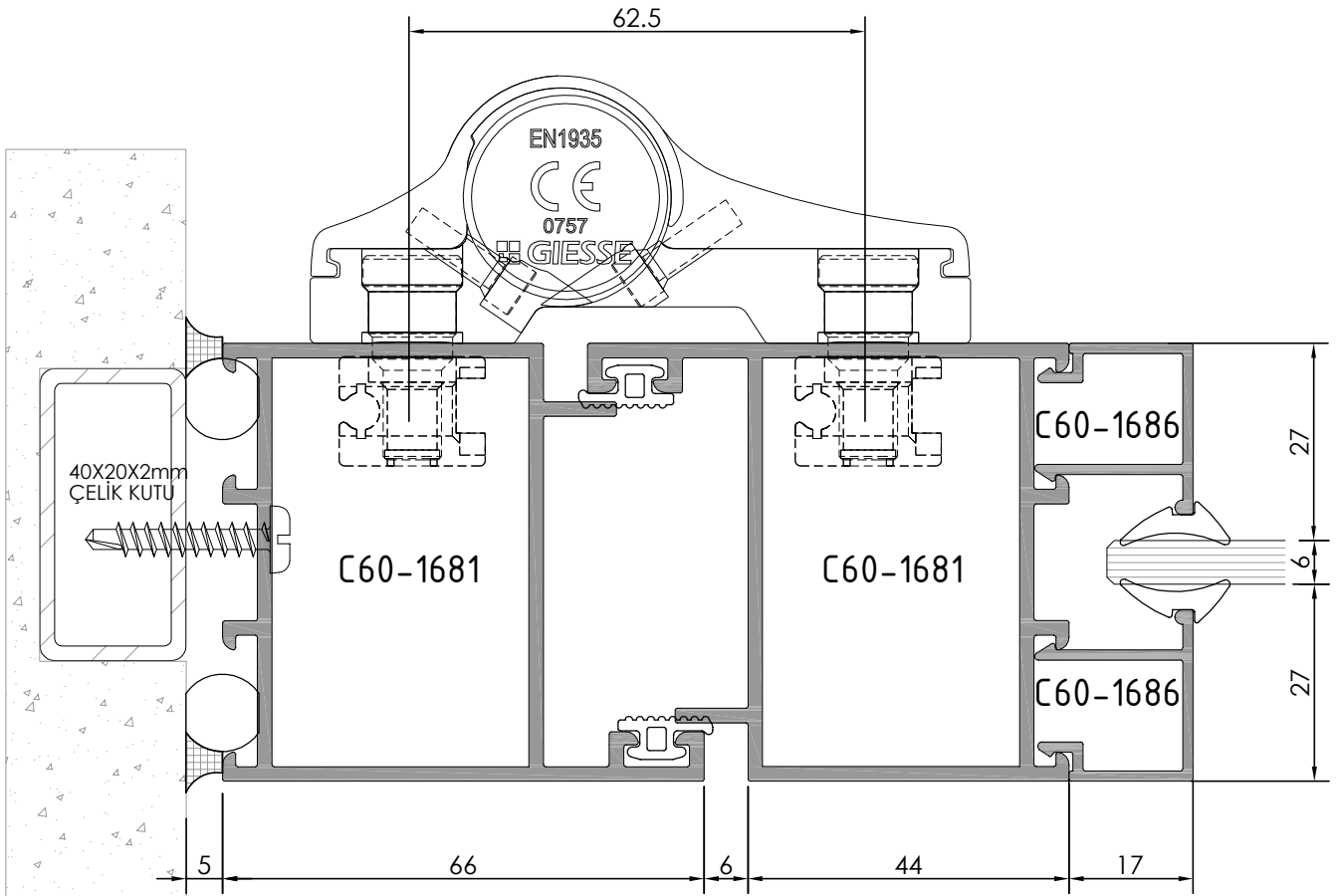
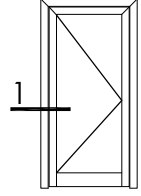

DETAY - 1

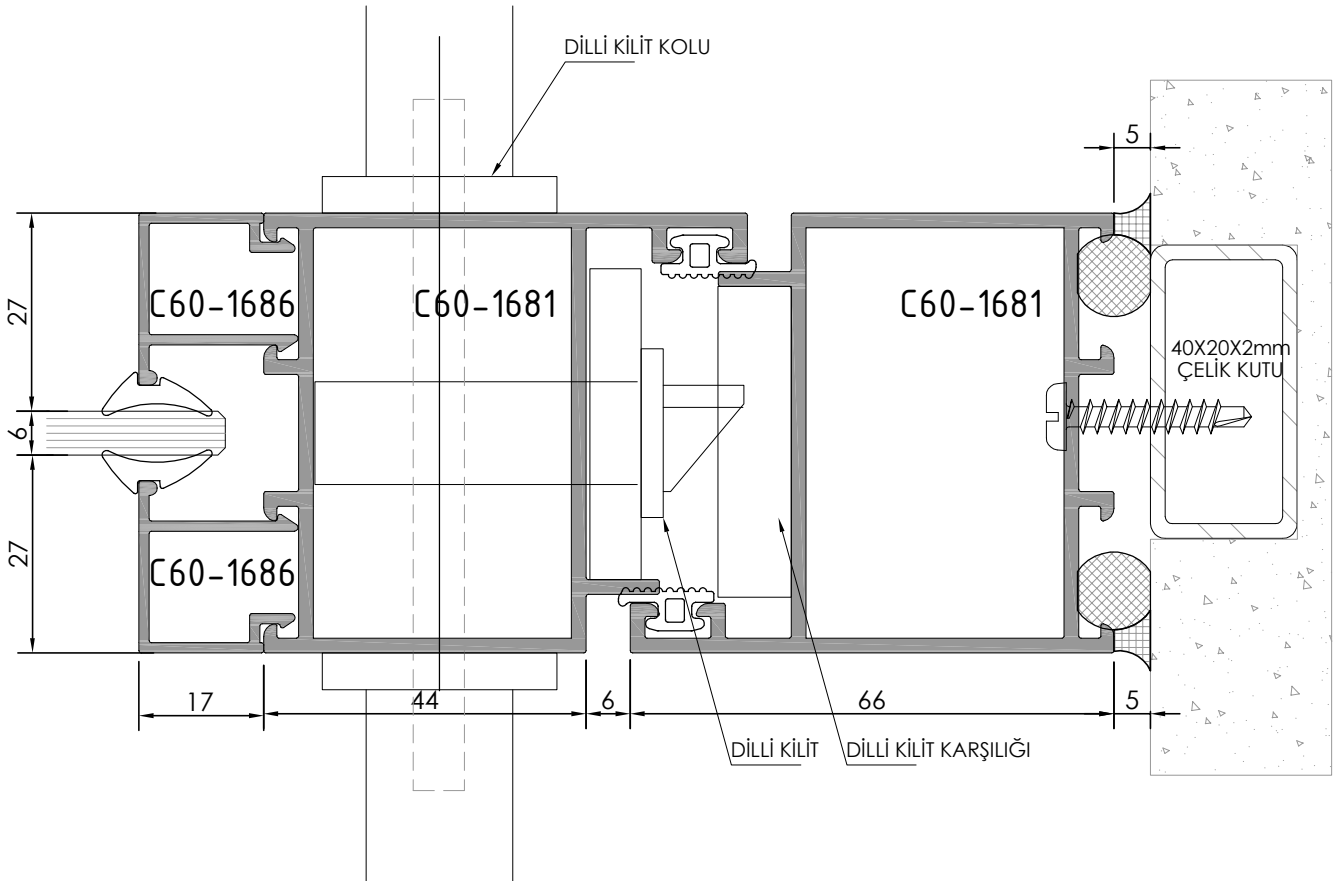
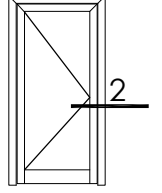

DETAY - 2

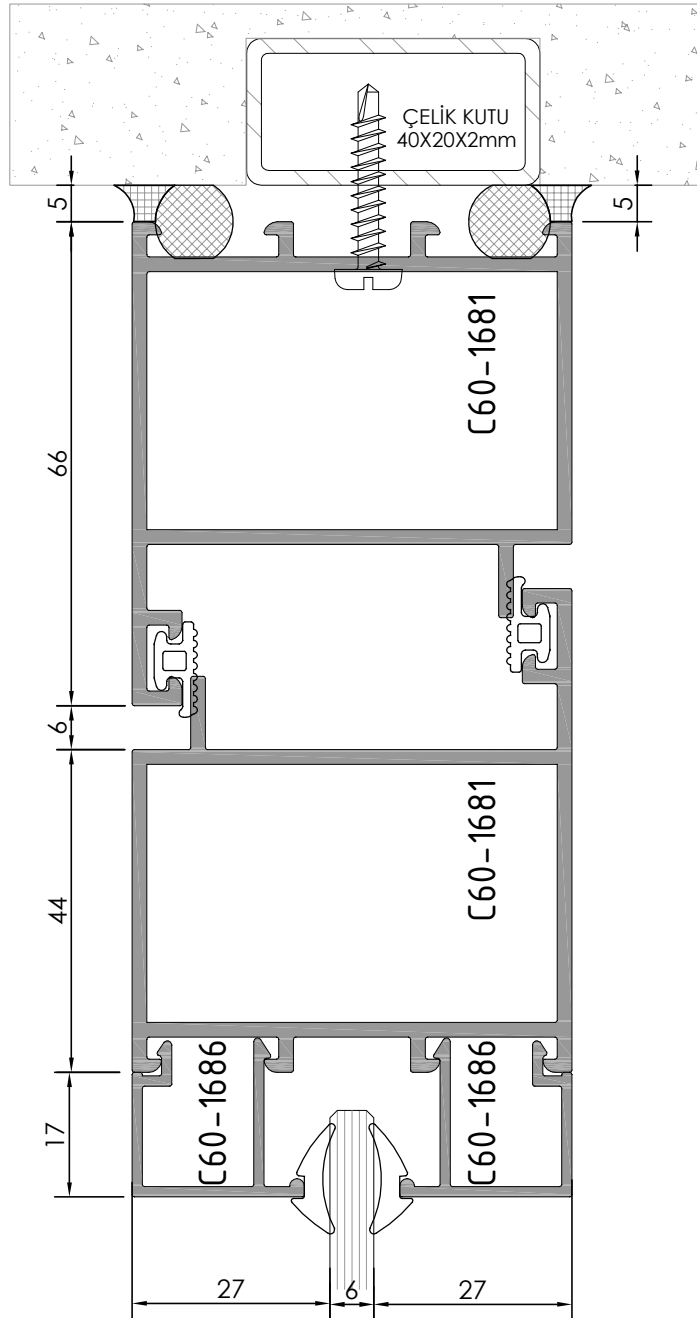
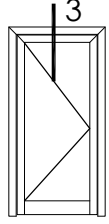

DETAY - 3

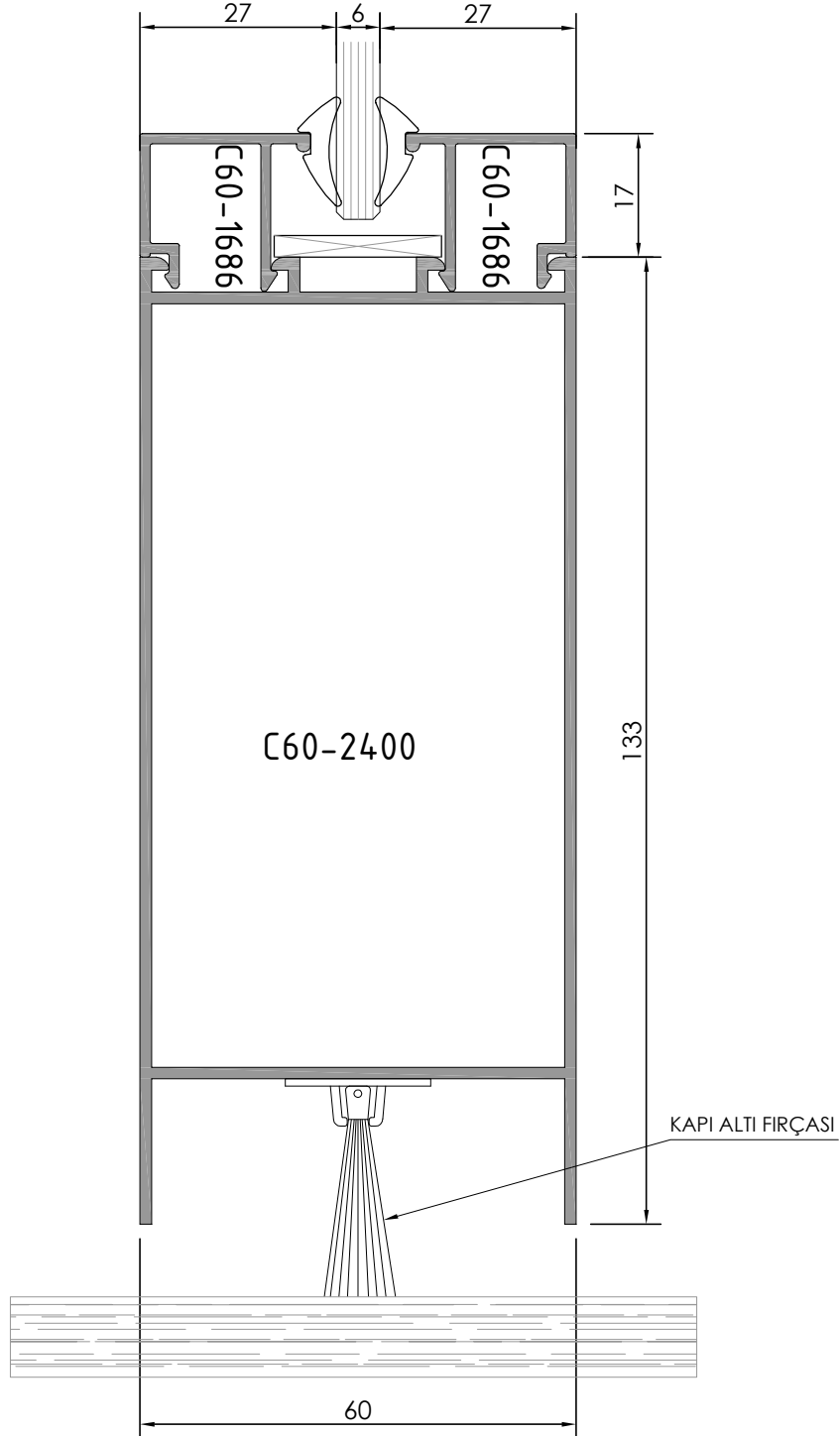
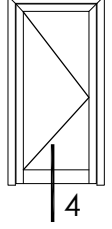

DETAY - 4

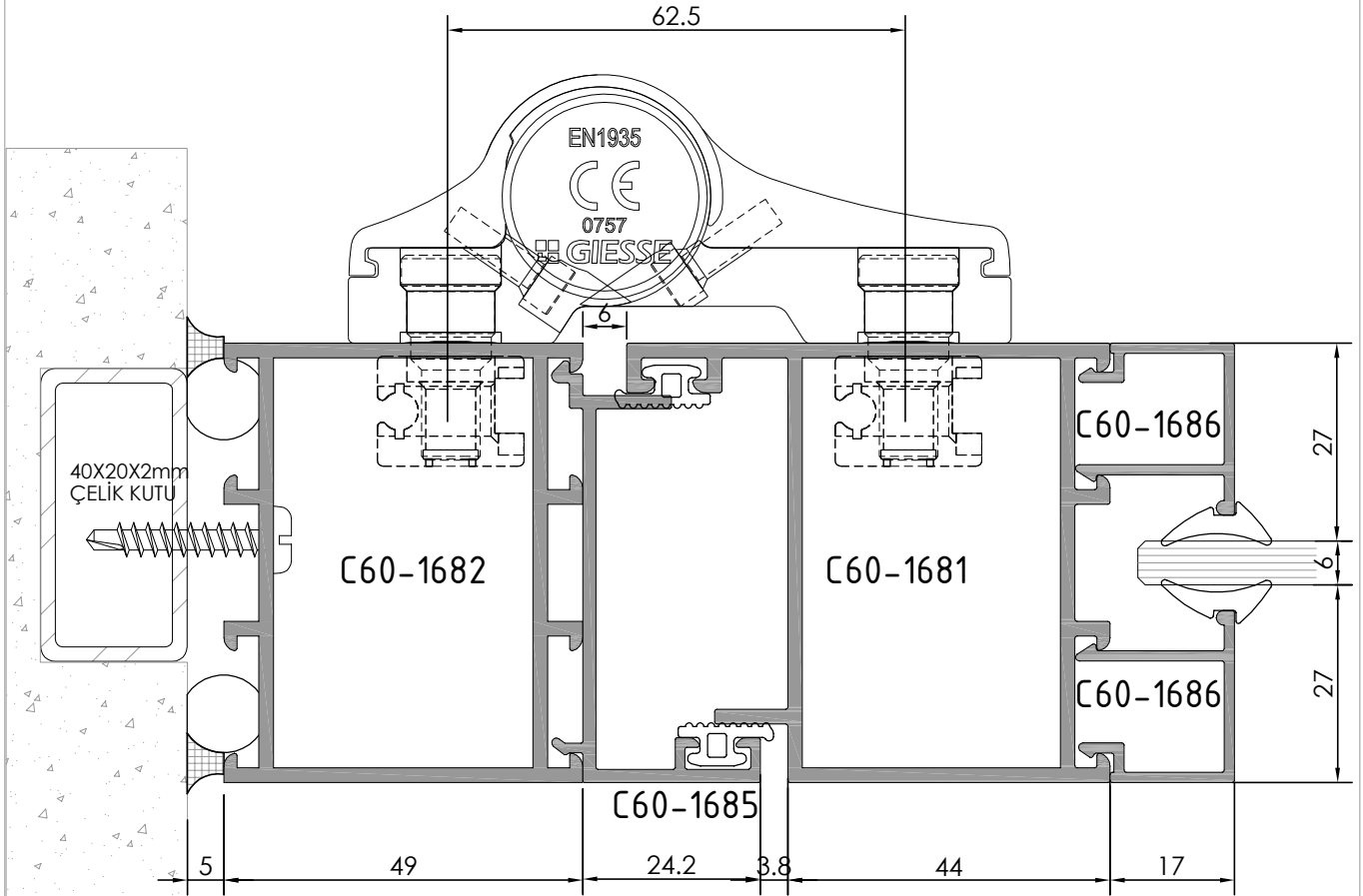
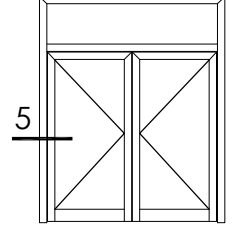

DETAY - 5

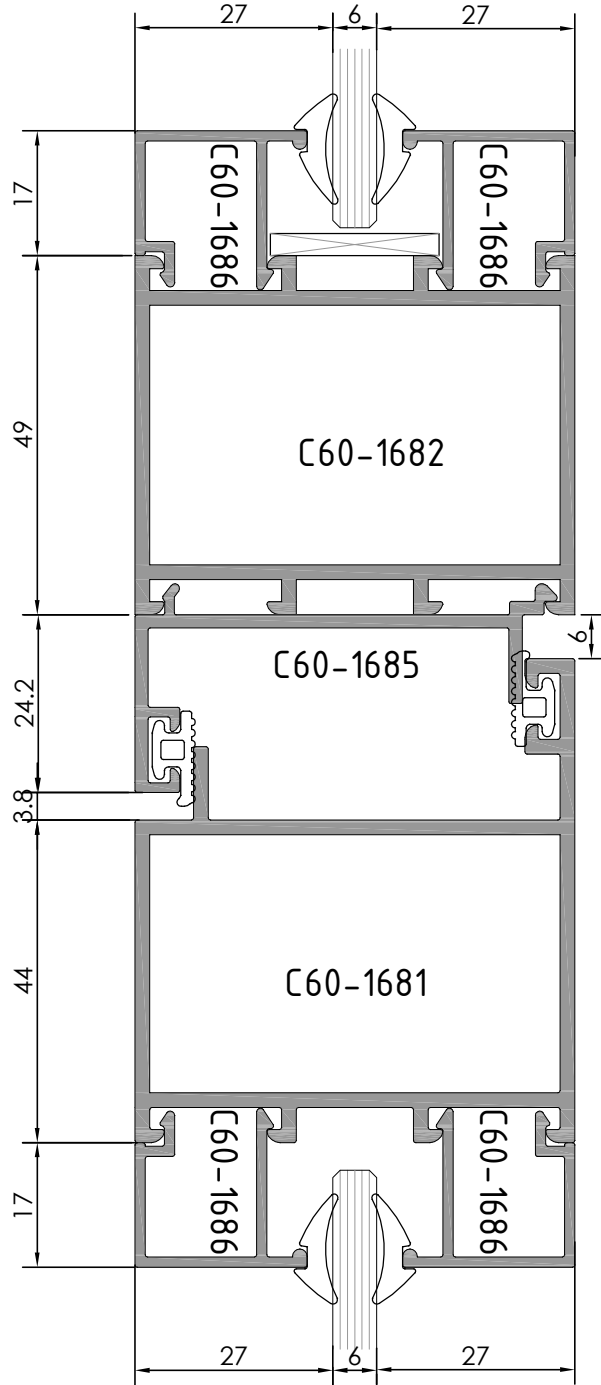

DETAY - 6

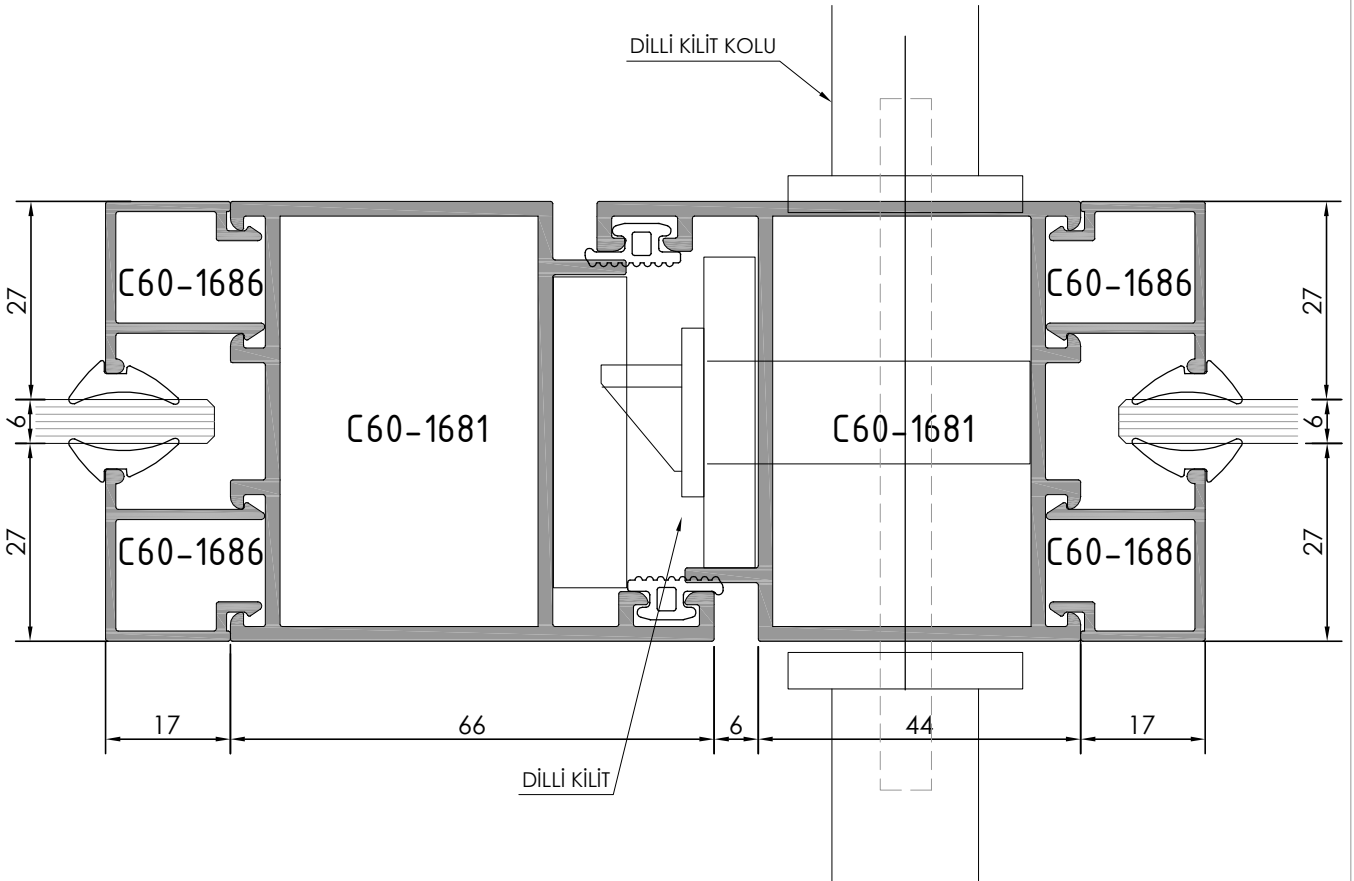
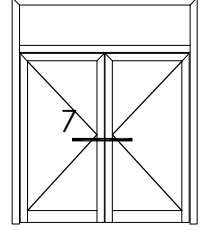

DETAY - 7

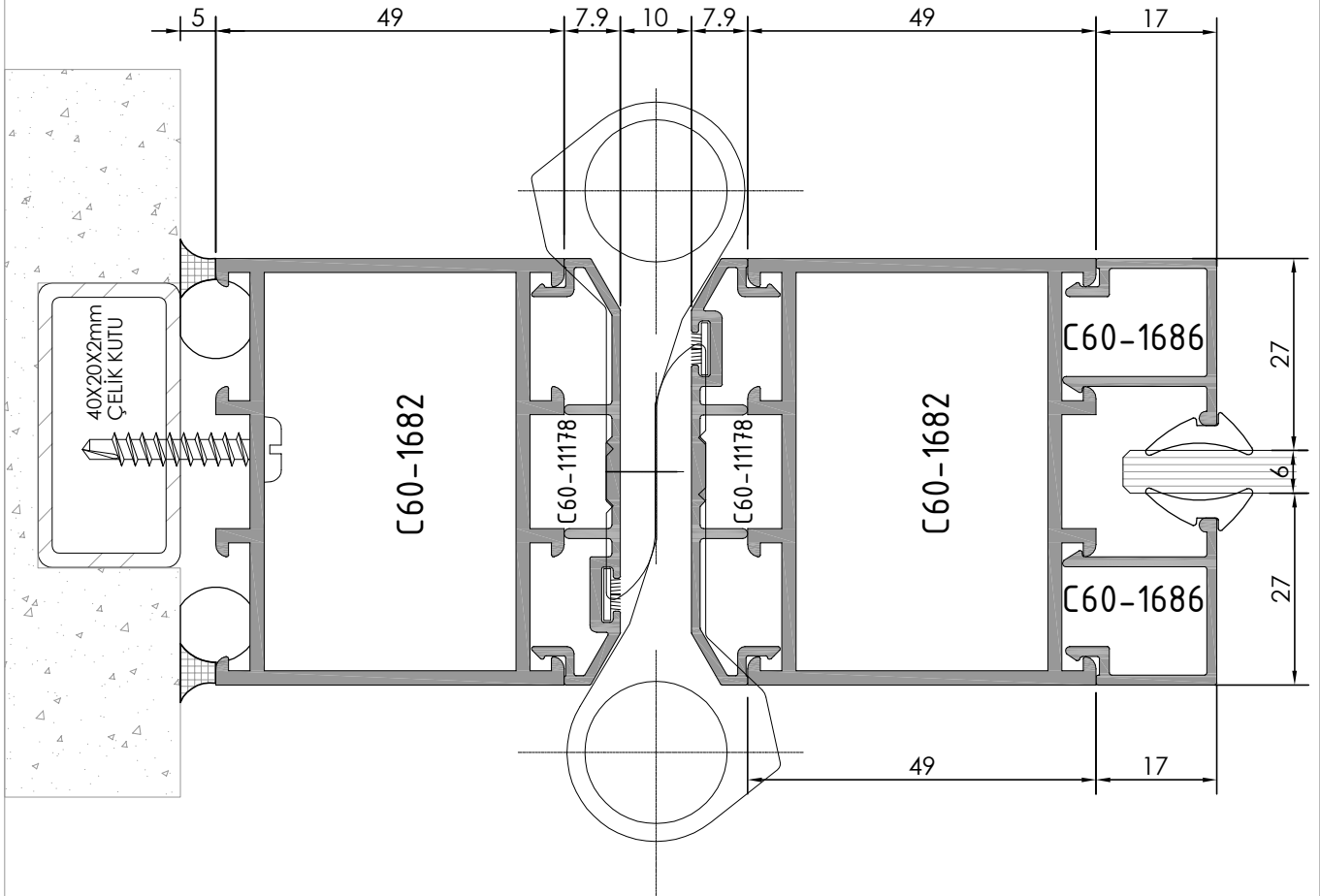
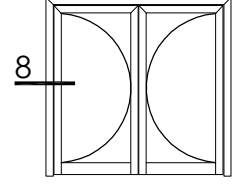

DETAY - 8

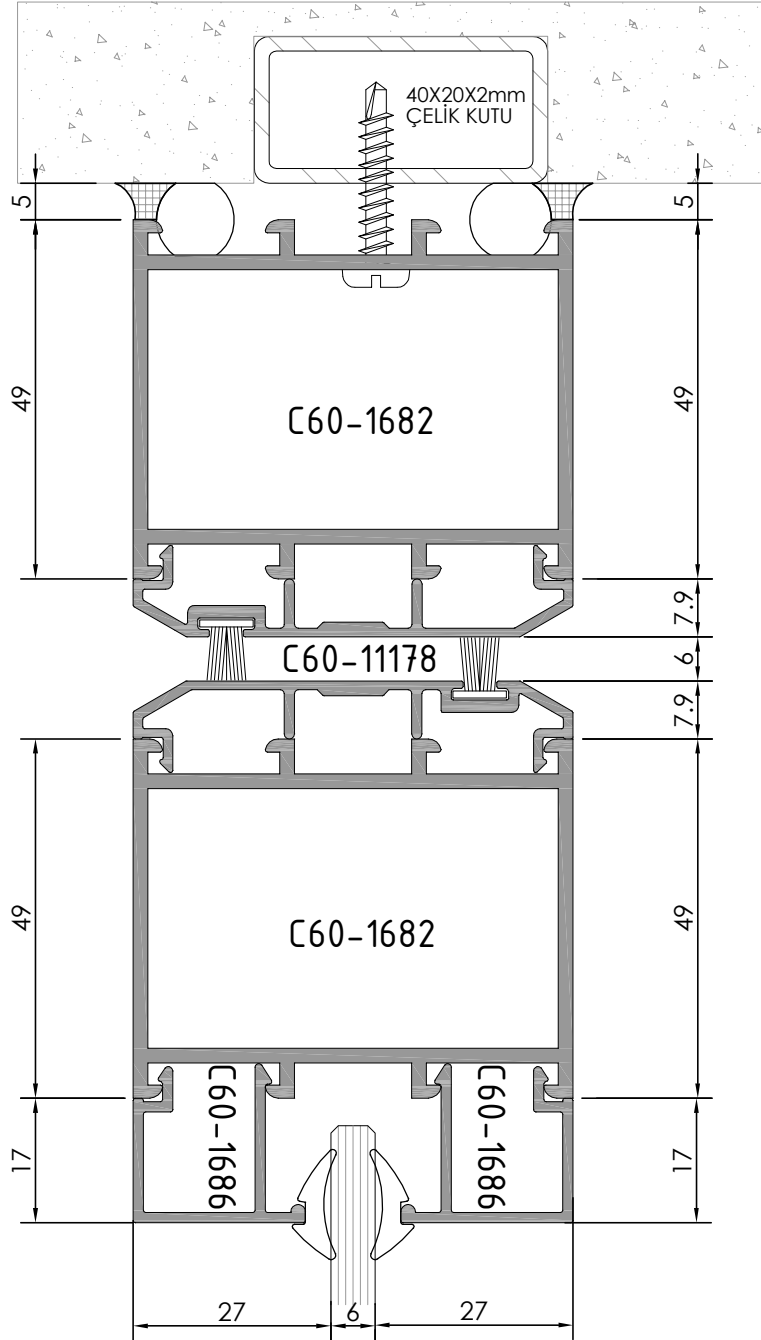
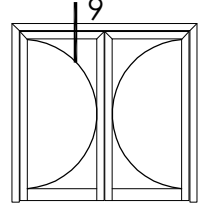

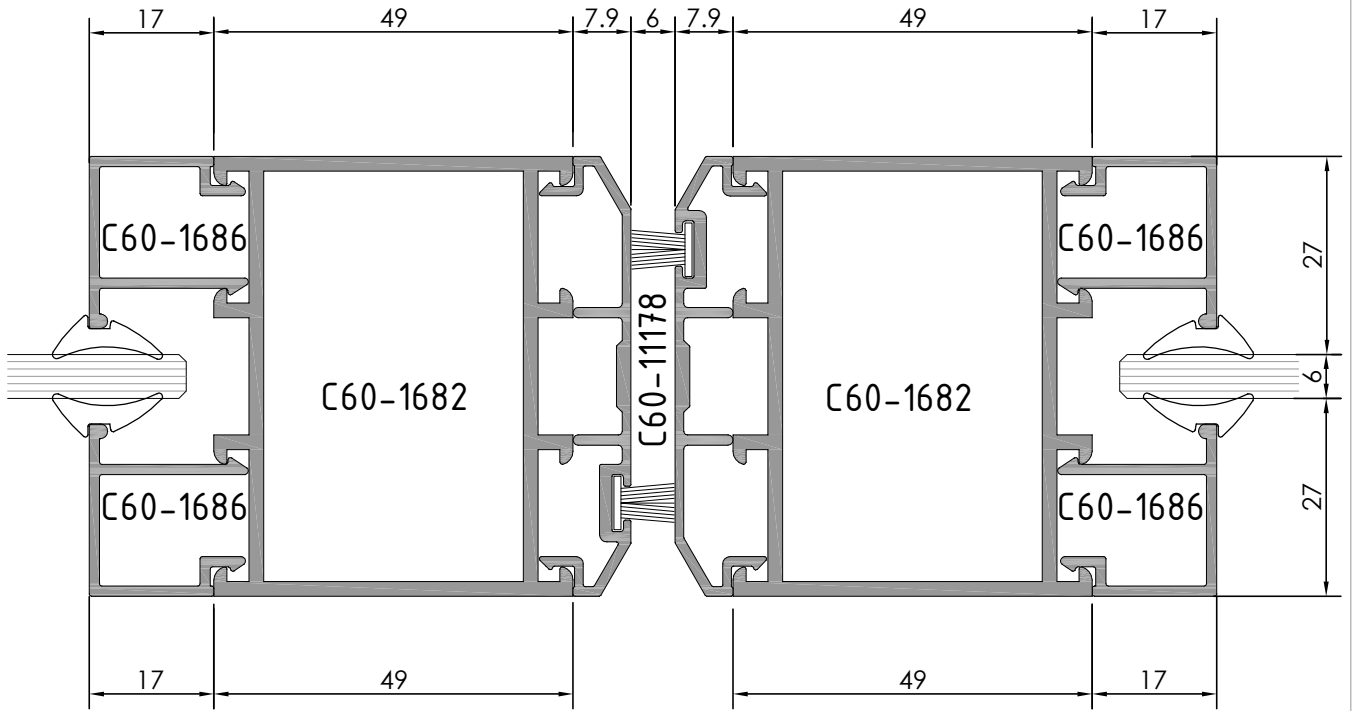
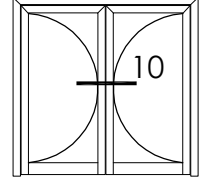

DETAY - 9



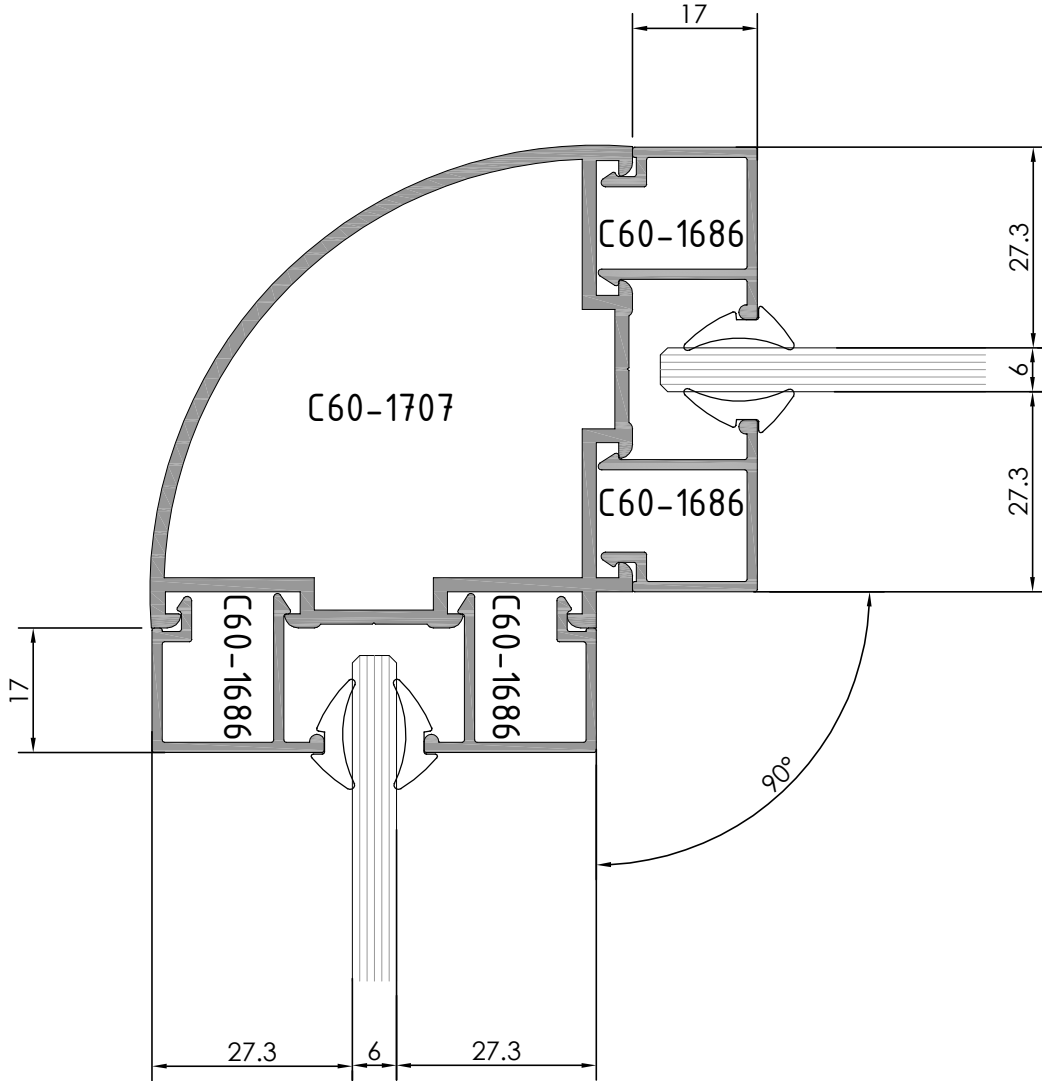
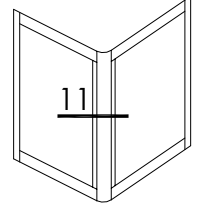

DETAY - 10

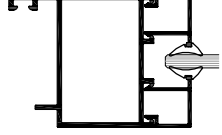

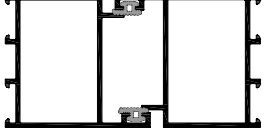
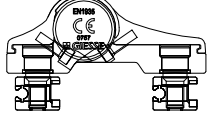
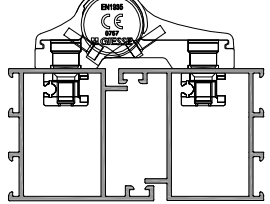
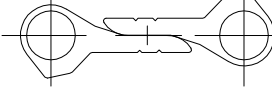
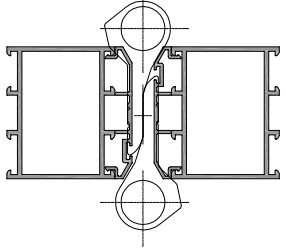
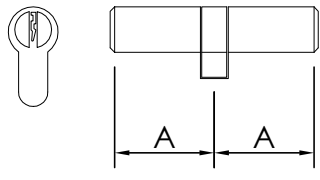
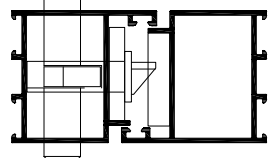
DETAY - 11

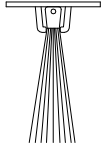
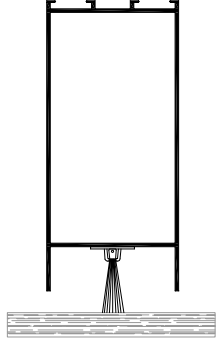
AKSESUAR KODU	AKSESUAR RESMI	AKSESUAR TANIM	DETAY
W-719		CAM FİTİLİ	
C60-710		BİNİ FİTİLİ 49 gr/m	
İki yapraklı kapı menteşesi D-800 (ithal) naturel eloksalli D-800-a (yerli) ----- D-801 (ithal) pres veya renkli D-801-a (yerli)		KAPI MENTEŞESİ	
Çarpma kapı menteşesi D-818 (ithal) naturel eloksalli D-818-a (yerli) ----- D-819 (ithal) pres veya renkli D-819-a (yerli)		Çarpma kapı menteşesi	
80.lik BAREL		BAREL	

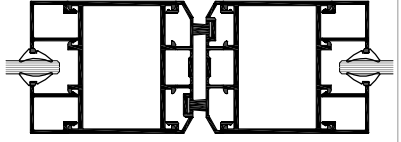
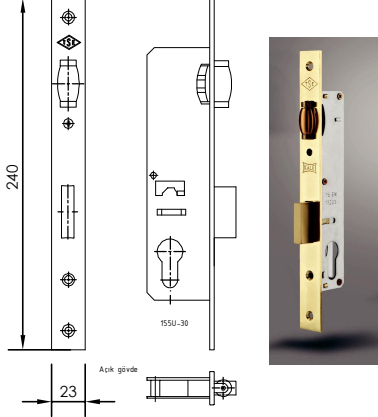
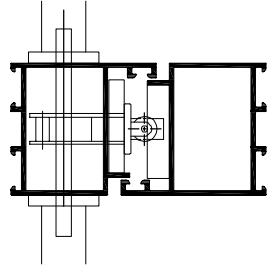
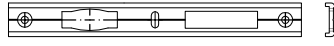
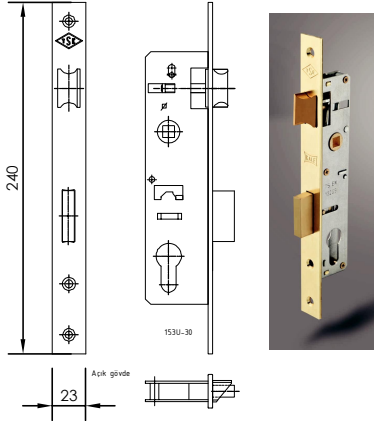
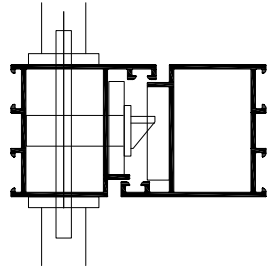
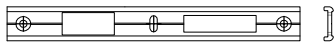
AKSESUAR KODU	AKSESUAR RESMİ	AKSESUAR TANIM	DETAY
D-873 (yerli)		KAPI ALTI FIRCASI	
ÇARPMA PROFİL KIL FİTİLİ		ÇARPMA PROFİL KIL FİTİLİ	
ÇARPMA KAPI KİLİT D-876 (yerli) metalik		Dar kilit (makaralı)	
D-854 (yerli) naturel eloksalli D-855 (yerli) pres veya renkli		Kilit Karşılığı	
DİLLİ KİLİT D-874 (yerli) metalik		Dar kilit (dilli)	
D-851 (yerli) naturel eloksalli D-852 (yerli) pres veya renkli		Kilit Karşılığı	



**C60**  
**C60 YALITIMSIZ SERİ PROFİLLERİ**  
C60 ECHOTERM SERIES

**AKSESUARLAR**  
ACCESSOIRES

AKSESUAR KODU	AKSESUAR RESMI	AKSESUAR TANIM	DETAY																																																																																				
<p>D-833-X naturel eloksalli (mat anodized)</p> <p>D-834-X pres veya renkli (mill finishand and painted)</p>		Boru kol	<table border="1"><thead><tr><th>X</th><th>Ø</th><th>R</th><th>A</th><th>B</th><th>C</th><th>D</th></tr></thead><tbody><tr><td>1</td><td>20</td><td>25</td><td>110</td><td>110</td><td>60</td><td>55</td></tr><tr><td>2</td><td>20</td><td>25</td><td>150</td><td>130</td><td>60</td><td>75</td></tr><tr><td>3</td><td>20</td><td>25</td><td>200</td><td>140</td><td>60</td><td>100</td></tr><tr><td>4</td><td>25</td><td>40</td><td>200</td><td>150</td><td>80</td><td>100</td></tr><tr><td>5</td><td>25</td><td>40</td><td>300</td><td>210</td><td>80</td><td>150</td></tr><tr><td>6</td><td>25</td><td>40</td><td>400</td><td>250</td><td>80</td><td>200</td></tr><tr><td>7</td><td>30</td><td>55</td><td>300</td><td>250</td><td>80</td><td>150</td></tr><tr><td>8</td><td>30</td><td>55</td><td>350</td><td>250</td><td>80</td><td>175</td></tr><tr><td>9</td><td>32</td><td>55</td><td>300</td><td>250</td><td>80</td><td>150</td></tr><tr><td>10</td><td>32</td><td>55</td><td>350</td><td>175</td><td>80</td><td>175</td></tr></tbody></table>	X	Ø	R	A	B	C	D	1	20	25	110	110	60	55	2	20	25	150	130	60	75	3	20	25	200	140	60	100	4	25	40	200	150	80	100	5	25	40	300	210	80	150	6	25	40	400	250	80	200	7	30	55	300	250	80	150	8	30	55	350	250	80	175	9	32	55	300	250	80	150	10	32	55	350	175	80	175							
X	Ø	R	A	B	C	D																																																																																	
1	20	25	110	110	60	55																																																																																	
2	20	25	150	130	60	75																																																																																	
3	20	25	200	140	60	100																																																																																	
4	25	40	200	150	80	100																																																																																	
5	25	40	300	210	80	150																																																																																	
6	25	40	400	250	80	200																																																																																	
7	30	55	300	250	80	150																																																																																	
8	30	55	350	250	80	175																																																																																	
9	32	55	300	250	80	150																																																																																	
10	32	55	350	175	80	175																																																																																	
<p>D-836-X naturel eloksalli (mat anodized)</p> <p>D-837-X pres veya renkli (mill finishand and painted)</p>		Boru kol	<table border="1"><thead><tr><th>X</th><th>Ø</th><th>R</th><th>A</th><th>B</th><th>C</th></tr></thead><tbody><tr><td>1</td><td>20</td><td>25</td><td>110</td><td>90</td><td>60</td></tr><tr><td>2</td><td>20</td><td>25</td><td>150</td><td>90</td><td>60</td></tr><tr><td>3</td><td>20</td><td>25</td><td>200</td><td>90</td><td>60</td></tr><tr><td>4</td><td>25</td><td>40</td><td>200</td><td>100</td><td>80</td></tr><tr><td>5</td><td>25</td><td>40</td><td>250</td><td>100</td><td>80</td></tr><tr><td>6</td><td>25</td><td>40</td><td>300</td><td>100</td><td>80</td></tr><tr><td>7</td><td>25</td><td>40</td><td>350</td><td>100</td><td>80</td></tr><tr><td>8</td><td>25</td><td>40</td><td>400</td><td>100</td><td>80</td></tr><tr><td>9</td><td>30</td><td>40</td><td>300</td><td>100</td><td>80</td></tr><tr><td>10</td><td>30</td><td>50</td><td>350</td><td>130</td><td>80</td></tr><tr><td>11</td><td>30</td><td>50</td><td>600</td><td>130</td><td>80</td></tr><tr><td>12</td><td>32</td><td>50</td><td>300</td><td>150</td><td>80</td></tr><tr><td>13</td><td>32</td><td>50</td><td>350</td><td>150</td><td>80</td></tr></tbody></table>	X	Ø	R	A	B	C	1	20	25	110	90	60	2	20	25	150	90	60	3	20	25	200	90	60	4	25	40	200	100	80	5	25	40	250	100	80	6	25	40	300	100	80	7	25	40	350	100	80	8	25	40	400	100	80	9	30	40	300	100	80	10	30	50	350	130	80	11	30	50	600	130	80	12	32	50	300	150	80	13	32	50	350	150	80
X	Ø	R	A	B	C																																																																																		
1	20	25	110	90	60																																																																																		
2	20	25	150	90	60																																																																																		
3	20	25	200	90	60																																																																																		
4	25	40	200	100	80																																																																																		
5	25	40	250	100	80																																																																																		
6	25	40	300	100	80																																																																																		
7	25	40	350	100	80																																																																																		
8	25	40	400	100	80																																																																																		
9	30	40	300	100	80																																																																																		
10	30	50	350	130	80																																																																																		
11	30	50	600	130	80																																																																																		
12	32	50	300	150	80																																																																																		
13	32	50	350	150	80																																																																																		
<p>D-839-X naturel eloksalli (mat anodized)</p> <p>D-840-X pres veya renkli (mill finishand and painted)</p>		Boru kol	<table border="1"><thead><tr><th>X</th><th>Ø</th><th>R</th><th>A</th><th>B</th><th>C</th></tr></thead><tbody><tr><td>1</td><td>30</td><td>750</td><td>600</td><td>1500</td><td>75</td></tr><tr><td>2</td><td>30</td><td>750</td><td>750</td><td>600</td><td>75</td></tr></tbody></table>	X	Ø	R	A	B	C	1	30	750	600	1500	75	2	30	750	750	600	75																																																																		
X	Ø	R	A	B	C																																																																																		
1	30	750	600	1500	75																																																																																		
2	30	750	750	600	75																																																																																		
<p>Supermaster ikili kapı kolu</p> <p>D-830 (ithal) naturel eloksalli D-830-a (yerli)</p> <p>D-831 (ithal) pres veya renkli D-831-a (yerli)</p>		KİLİT KOLU																																																																																					